

Turbo 2 ultrafast high voltage rectifier

Main product characteristics

$I_{F(AV)}$	5 A
V_{RRM}	600 V
I_R (max)	125 μ A / 150 μ A
T_j (max)	175 °C
V_F (max)	1.05 V
t_{rr} (max)	95 ns

Features and benefits

- Ultrafast switching
- Low reverse recovery current
- Reduces switching & conduction losses
- Low thermal resistance

Description

The STTH5L06, which uses ST Turbo 2 600V technology, is specially suited as boost diode in discontinuous or critical mode power factor corrections.

This device, available in TO-220AC, TO-220FPAC, DPAK and DO-201AD, is also intended for use as a free wheeling diode in power supplies and other power switching applications

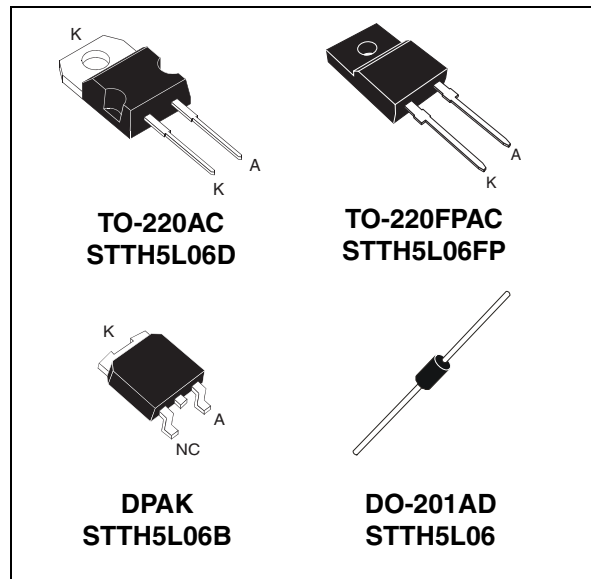

Order codes

Part number	Marking
STTH5L06	STTH5L06
STTH5L06RL	STTH5L06
STTH5L06D	STTH5L06D
STTH5L06B	STTH5L06B
STTH5L06B-TR	STTH5L06B
STTH5L06FP	STTH5L06FP

1 Characteristics

Table 1. Absolute ratings (limiting values)

Symbol	Parameter		Value	Unit	
V_{RRM}	Repetitive peak reverse voltage		600	V	
$I_{F(RMS)}$	RMS forward current	TO-220AC, TO-220FPAC, DO-201AD	20	A	
		DPAK	10		
$I_{F(AV)}$	Average forward current	TO-220AC, DPAK	$T_c = 150\text{ }^\circ\text{C}$ $\delta = 0.5$	5	A
		DO-210AD	$T_l = 50\text{ }^\circ\text{C}$ $\delta = 0.5$		
		TO-220FPAC	$T_c = 135\text{ }^\circ\text{C}$ $\delta = 0.5$		
I_{FRM}	Repetitive peak forward current		$t_p = 5\text{ }\mu\text{s}$, $F = 5\text{ kHz}$ square	65	A
I_{FSM}	Surge non repetitive forward current	$t_p = 10\text{ ms}$ Sinusoidal	TO-220AC, TO-220FPAC	90	A
			DO-201AD	110	
			DPAK	60	
T_{stg}	Storage temperature range		- 65 + 175	$^\circ\text{C}$	
T_j	Maximum operating junction temperature		+ 175	$^\circ\text{C}$	

Table 2. Thermal parameters

Symbol	Parameter		Maximum	Unit
$R_{th(j-c)}$	Junction to case	TO-220AC, DPAK	3.5	$^\circ\text{C/W}$
		TO-220FPAC	6.0	
$R_{th(j-l)}$	Junction to lead	L = 10 mm	20	
$R_{th(j-a)}$	Junction to ambient (1)		DO-201AD	

1. With recommended pad layout (see [Figure 15](#))

Table 3. Static electrical characteristics

Symbol	Parameter	Tests conditions		Min.	Typ.	Max.	Unit	
I_R	Reverse leakage current	$V_R = 600\text{ V}$	$T_j = 25\text{ }^\circ\text{C}$			5	μA	
			$T_j = 150\text{ }^\circ\text{C}$	TO-220AC, DPAK, TO-220FPAC		10		125
				DO-201AD		25		150
V_F	Forward voltage drop	$I_F = 5\text{ A}$	$T_j = 25\text{ }^\circ\text{C}$			1.3	V	
			$T_j = 150\text{ }^\circ\text{C}$		0.85	1.05		

To evaluate the maximum conduction losses use the following equation:

$$P = 0.89 \times I_{F(AV)} + 0.033 I_{F(RMS)}^2$$

Table 4. Dynamic electrical characteristics

Symbol	Parameter	Tests conditions	Min.	Typ.	Max.	Unit
t_{rr}	Reverse recovery time	$I_F = 1\text{ A}$ $di_F/dt = -50\text{ A}/\mu\text{s}$ $V_R = 30\text{ V}$		65	95	ns
t_{fr}	Forward recovery time	$I_F = 5\text{ A}$ $di_F/dt = 100\text{ A}/\mu\text{s}$ $V_{FR} = 1.1 \times V_{Fmax}$			150	ns
V_{FP}	Forward recovery time	$I_F = 5\text{ A}$ $di_F/dt = 100\text{ A}/\mu\text{s}$			7	V

Figure 1. Conduction losses versus average current

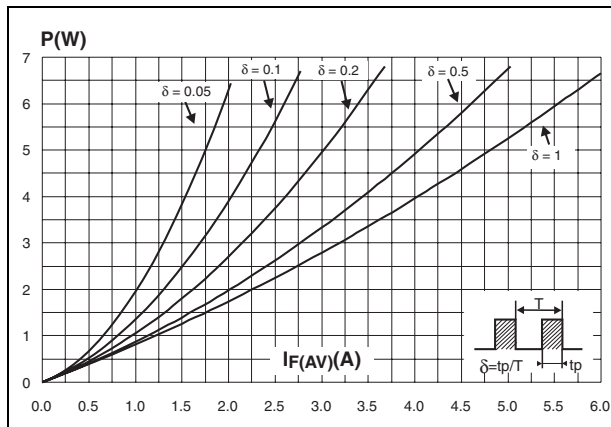

Figure 2. Forward voltage drop versus forward current

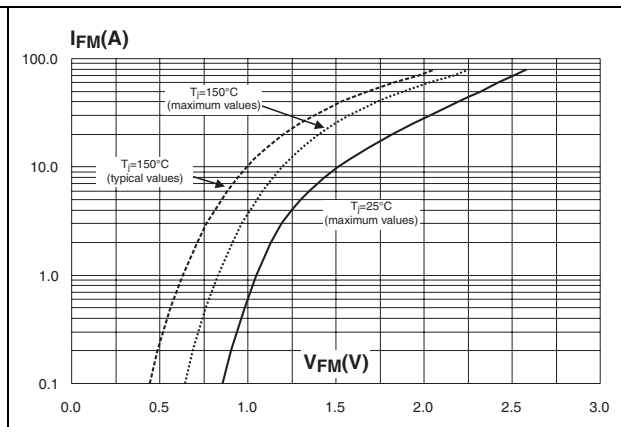

Figure 3. Relative variation of thermal impedance junction to case versus pulse duration (TO-220AC, DPAK)

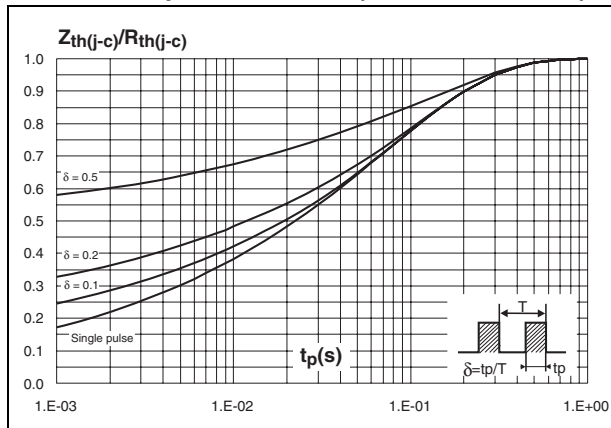

Figure 4. Relative variation of thermal impedance junction to case versus pulse duration (TO-220FPAC)

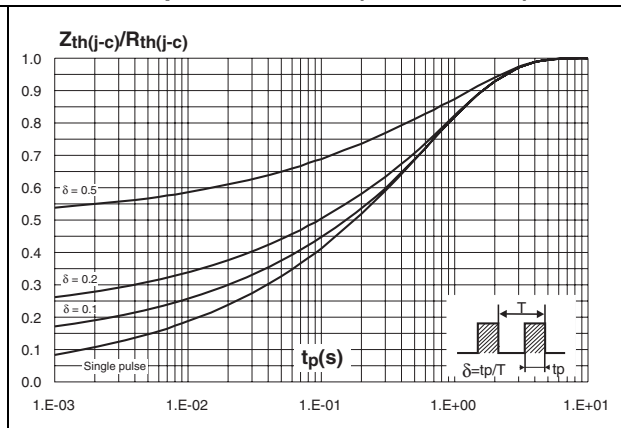

Figure 5. Relative variation of thermal impedance junction ambient versus pulse duration (Epoxy FR4, $L_{leads} = 10$ mm) (DO-201AD)

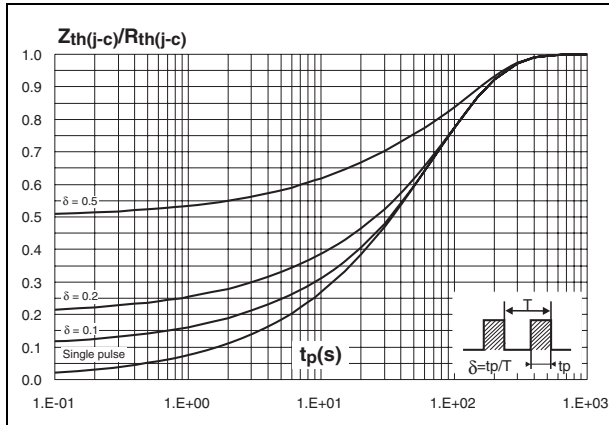

Figure 6. Peak reverse recovery current versus di_F/dt (90% confidence)

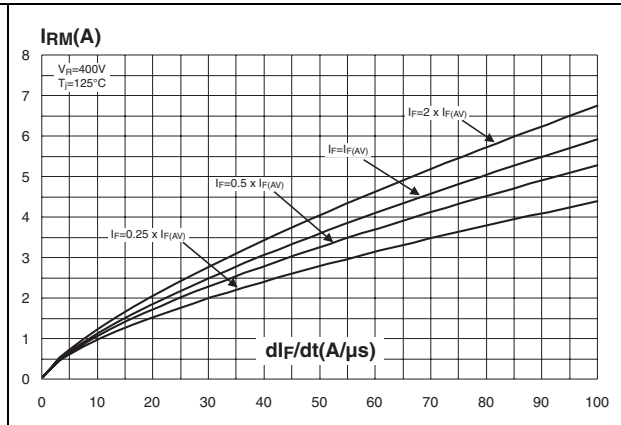

Figure 7. Reverse recovery time versus di_F/dt (90% confidence)

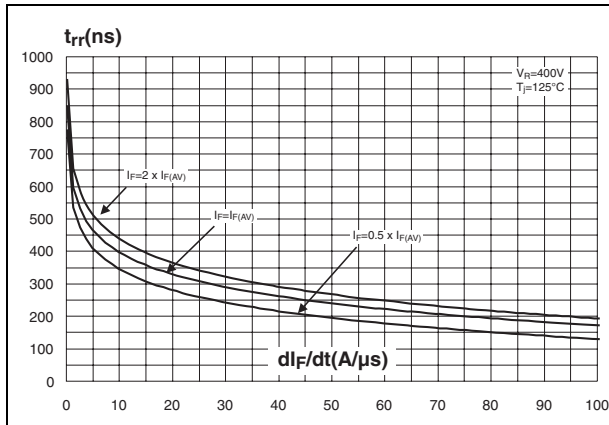

Figure 8. Reverse recovery charges versus di_F/dt (90% confidence)

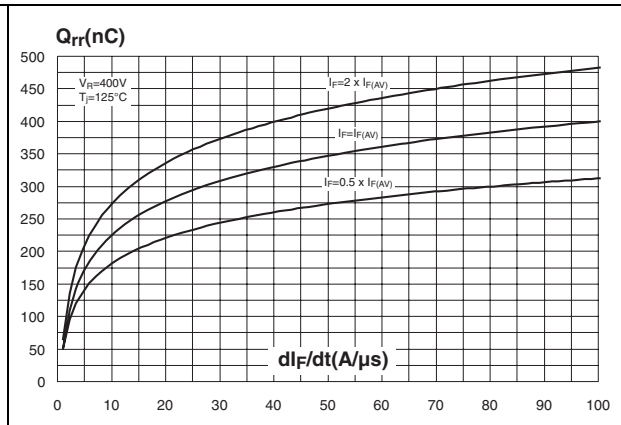

Figure 9. Softness factor versus di_F/dt (typical values)

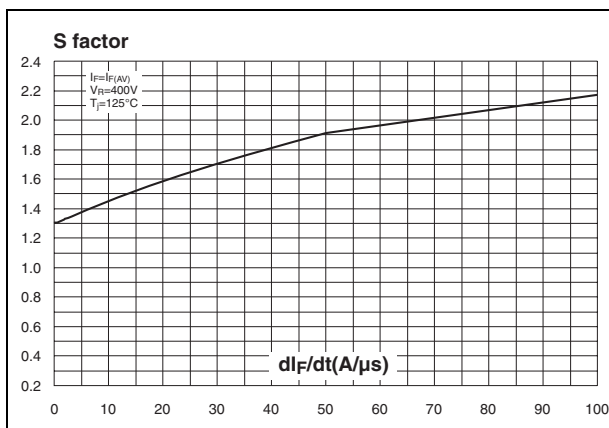

Figure 10. Relative variations of dynamic parameters versus junction temperature

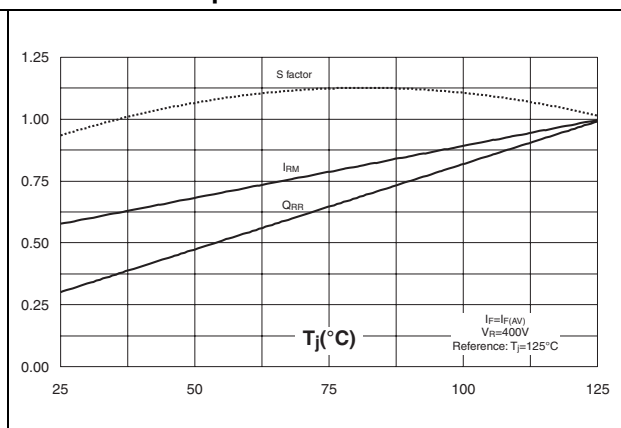

Figure 11. Transient peak forward voltage versus di_F/dt (90% confidence)

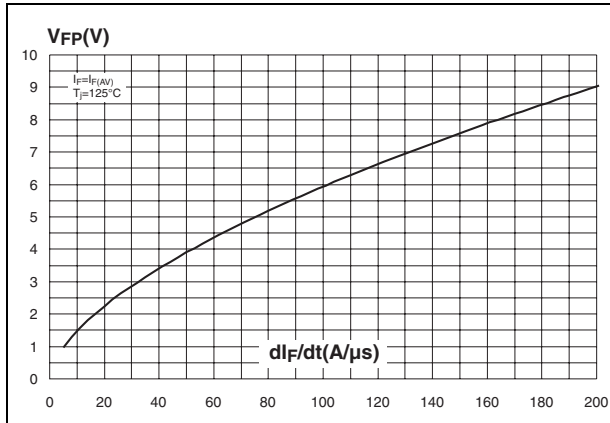

Figure 12. Forward recovery time versus di_F/dt (90% confidence)

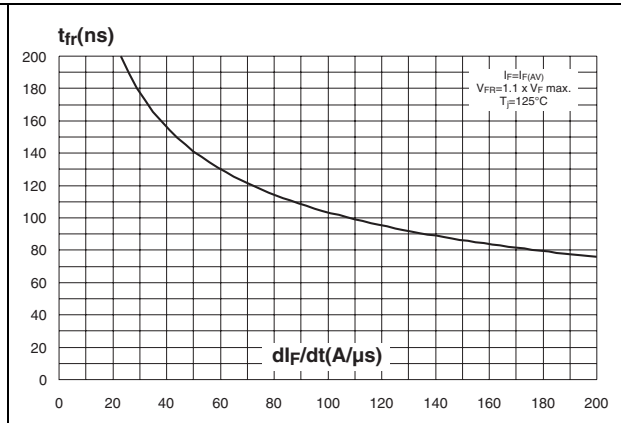

Figure 13. Junction capacitance versus reverse voltage applied (typical values)

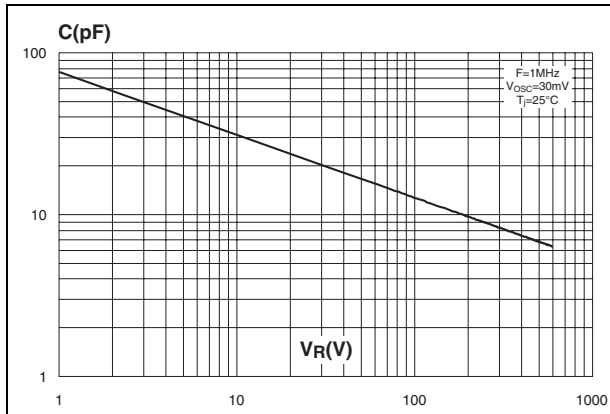

Figure 14. Thermal resistance junction to ambient versus copper surface under tab (epoxy FR4, $e_{CU} = 35 \mu m$) (DPAK)

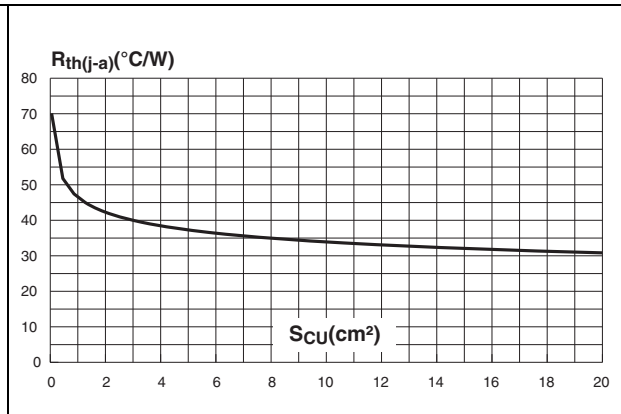
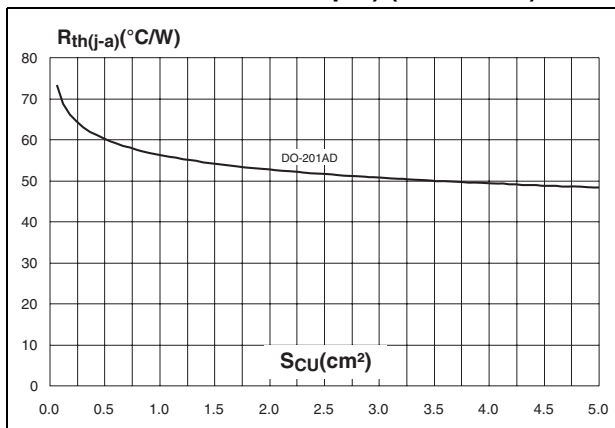

Figure 15. Thermal resistance junction to ambient versus copper surface under each lead (epoxy printed circuit board FR4, copper thickness: $35 \mu m$) (DO-201AD)



2 Package information

- Epoxy meets UL94, V0
- Cooling method: by conduction (C)
- Recommended torque value: 0.8 Nm (TO-220FPAC) / 0.55 Nm (TO-220AC)
- Maximum torque value: 1.0 Nm (TO-220FPAC) / 0.70 Nm (TO-220AC)

Table 5. TO-220AC dimensions

Ref.	Dimensions			
	Millimeters		Inches	
	Min.	Max.	Min.	Max.
A	4.40	4.60	0.173	0.181
C	1.23	1.32	0.048	0.051
D	2.40	2.72	0.094	0.107
E	0.49	0.70	0.019	0.027
F	0.61	0.88	0.024	0.034
F1	1.14	1.70	0.044	0.066
G	4.95	5.15	0.194	0.202
H2	10.00	10.40	0.393	0.409
L2	16.40 typ.		0.645 typ.	
L4	13.00	14.00	0.511	0.551
L5	2.65	2.95	0.104	0.116
L6	15.25	15.75	0.600	0.620
L7	6.20	6.60	0.244	0.259
L9	3.50	3.93	0.137	0.154
M	2.6 typ.		0.102 typ.	
Diam. I	3.75	3.85	0.147	0.151

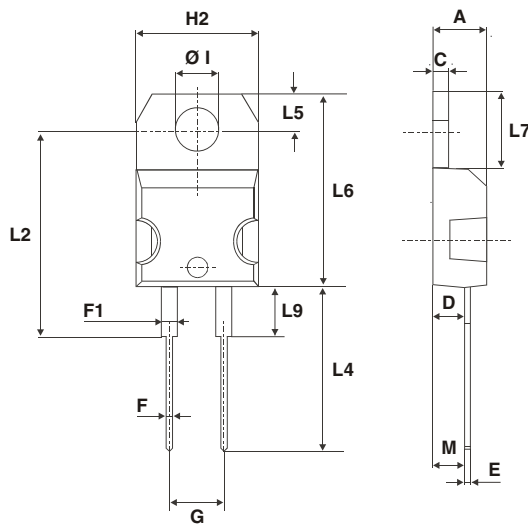

Table 6. TO-220FPAC dimensions

Ref.	Dimensions			
	Millimeters		Inches	
	Min.	Max.	Min.	Max.
A	4.4	4.6	0.173	0.181
B	2.5	2.7	0.098	0.106
D	2.5	2.75	0.098	0.108
E	0.45	0.70	0.018	0.027
F	0.75	1	0.030	0.039
F1	1.15	1.70	0.045	0.067
G	4.95	5.20	0.195	0.205
G1	2.4	2.7	0.094	0.106
H	10	10.4	0.393	0.409
L2	16 Typ.		0.63 Typ.	
L3	28.6	30.6	1.126	1.205
L4	9.8	10.6	0.386	0.417
L5	2.9	3.6	0.114	0.142
L6	15.9	16.4	0.626	0.646
L7	9.00	9.30	0.354	0.366
Dia.	3.00	3.20	0.118	0.126

Table 7. DO-201AD dimensions

Ref.	Dimensions			
	Millimeters		Inches	
	Min.	Max.	Min.	Max.
A		9.50		0.374
B	25.40		1.000	
C		5.30		0.209
D		1.30		0.051
E		1.25		0.049
Notes	1 - The lead diameter $\varnothing D$ is not controlled over zone E 2 - The minimum length which must stay straight between the right angles after bending is 0.59"(15mm)			

Table 8. DPAK dimensions

Ref.	Dimensions			
	Millimeters		Inches	
	Min.	Max.	Min.	Max.
A	2.20	2.40	0.086	0.094
A1	0.90	1.10	0.035	0.043
A2	0.03	0.23	0.001	0.009
B	0.64	0.90	0.025	0.035
B2	5.20	5.40	0.204	0.212
C	0.45	0.60	0.017	0.023
C2	0.48	0.60	0.018	0.023
D	6.00	6.20	0.236	0.244
E	6.40	6.60	0.251	0.259
G	4.40	4.60	0.173	0.181
H	9.35	10.10	0.368	0.397
L2	0.80 typ.		0.031 typ.	
L4	0.60	1.00	0.023	0.039
V2	0°	8°	0°	8°

Figure 16. DPAK footprint (dimensions in mm)

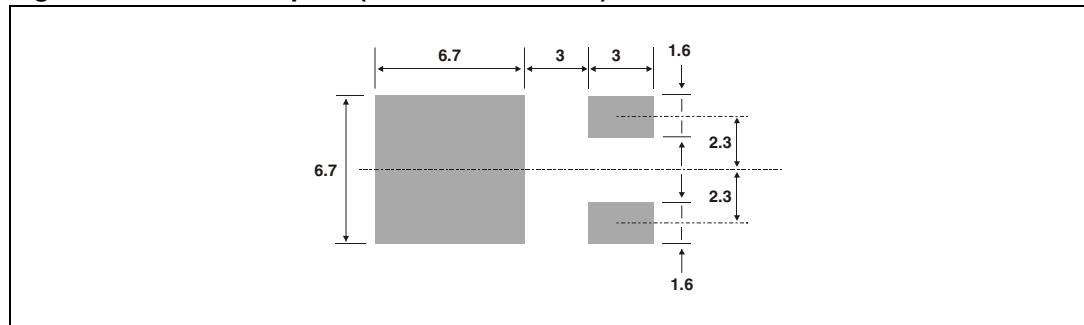

In order to meet environmental requirements, ST offers these devices in ECOPACK® packages. These packages have a lead-free second level interconnect. The category of second level interconnect is marked on the package and on the inner box label, in compliance with JEDEC Standard JESD97. The maximum ratings related to soldering conditions are also marked on the inner box label. ECOPACK is an ST trademark. ECOPACK specifications are available at: www.st.com.

3 Ordering information

Ordering code	Marking	Package	Weight	Base qty	Delivery mode
STTH5L06	STTH5L06	DO-201AD	1.16 G	600	Ammopack
STTH5L06RL	STTH5L06			1900	Tape & reel
STTH5L06D	STTH5L06D	TO-220AC	1.9 g	50	Tube
STTH5L06B	STTH5L06B	DPAK	0.3 g	75	Tube
STTH5L06B-TR	STTH5L06B			2500	Tape & reel
STTH5L06FP	STTH5L06FP	TO-220FPAC	1.7 g	50	Tube

4 Revision history

Date	Revision	Changes
Nov-2001	1A	Last release.
31-Mar-2007	2	Merge with TO-220AC, TO-220FPAC and DPAK version.

Please Read Carefully:

Information in this document is provided solely in connection with ST products. STMicroelectronics NV and its subsidiaries ("ST") reserve the right to make changes, corrections, modifications or improvements, to this document, and the products and services described herein at any time, without notice.

All ST products are sold pursuant to ST's terms and conditions of sale.

Purchasers are solely responsible for the choice, selection and use of the ST products and services described herein, and ST assumes no liability whatsoever relating to the choice, selection or use of the ST products and services described herein.

No license, express or implied, by estoppel or otherwise, to any intellectual property rights is granted under this document. If any part of this document refers to any third party products or services it shall not be deemed a license grant by ST for the use of such third party products or services, or any intellectual property contained therein or considered as a warranty covering the use in any manner whatsoever of such third party products or services or any intellectual property contained therein.

UNLESS OTHERWISE SET FORTH IN ST'S TERMS AND CONDITIONS OF SALE ST DISCLAIMS ANY EXPRESS OR IMPLIED WARRANTY WITH RESPECT TO THE USE AND/OR SALE OF ST PRODUCTS INCLUDING WITHOUT LIMITATION IMPLIED WARRANTIES OF MERCHANTABILITY, FITNESS FOR A PARTICULAR PURPOSE (AND THEIR EQUIVALENTS UNDER THE LAWS OF ANY JURISDICTION), OR INFRINGEMENT OF ANY PATENT, COPYRIGHT OR OTHER INTELLECTUAL PROPERTY RIGHT.

UNLESS EXPRESSLY APPROVED IN WRITING BY AN AUTHORIZED ST REPRESENTATIVE, ST PRODUCTS ARE NOT RECOMMENDED, AUTHORIZED OR WARRANTED FOR USE IN MILITARY, AIR CRAFT, SPACE, LIFE SAVING, OR LIFE SUSTAINING APPLICATIONS, NOR IN PRODUCTS OR SYSTEMS WHERE FAILURE OR MALFUNCTION MAY RESULT IN PERSONAL INJURY, DEATH, OR SEVERE PROPERTY OR ENVIRONMENTAL DAMAGE. ST PRODUCTS WHICH ARE NOT SPECIFIED AS "AUTOMOTIVE GRADE" MAY ONLY BE USED IN AUTOMOTIVE APPLICATIONS AT USER'S OWN RISK.

Resale of ST products with provisions different from the statements and/or technical features set forth in this document shall immediately void any warranty granted by ST for the ST product or service described herein and shall not create or extend in any manner whatsoever, any liability of ST.

ST and the ST logo are trademarks or registered trademarks of ST in various countries.

Information in this document supersedes and replaces all information previously supplied.

The ST logo is a registered trademark of STMicroelectronics. All other names are the property of their respective owners.

© 2007 STMicroelectronics - All rights reserved

STMicroelectronics group of companies

Australia - Belgium - Brazil - Canada - China - Czech Republic - Finland - France - Germany - Hong Kong - India - Israel - Italy - Japan - Malaysia - Malta - Morocco - Singapore - Spain - Sweden - Switzerland - United Kingdom - United States of America

www.st.com